

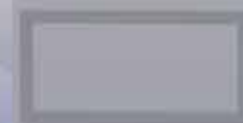

Catálogo de Produtos

Telefone:
(11) 2241-6700





A **MARTE ALUMÍNIO** UMA EMPRESA QUE HÁ MAIS DE 40 ANOS VEM PRESTANDO EXCELENTE ATENDIMENTO AOS SEUS CLIENTES, DISPONIBILIZA UMA AMPLA LINHA DE PRODUTOS E ACESSÓRIOS PARA ATENDER COM RAPIDEZ A CONSTANTE DEMANDA DO MERCADO.

SUA DIVERSIFICADA LINHA DE PERFIS DE ALUMÍNIO ANODIZADO E PINTADO, REPRESENTA UM DOS MAIORES ESTOQUES PARA PRONTA ENTREGA.

ENTRE SEUS PRINCIPAIS CLIENTES ESTÃO OS SERRALHEIROS, VIDRACEIROS E SEGMENTOS INDUSTRIAIS.

A **MARTE ALUMÍNIO** MANTÉM O COMPROMISSO E A TRADIÇÃO DO BOM RELACIONAMENTO COM SEUS PARCEIROS COLABORADORES, FORNECEDORES E CLIENTES.



ÍNDICE

TABELAS	04
PERFIS P/VIDRO 10 MM	07
PERFIS P/VIDRO 8 MM	09
DIVERSOS	11
DIVISÓRIA SANITÁRIA	11
FACHADA CORTINA	12
GUARDA-CORPO CORRIMÃO	13
VITRINE E TELA MOSQUETEIRA	15
MOLDURA DE ALUMÍNIO	16
PERFIL P/ MÓVEIS	16
ARREMATES (ESCADA E CARROCERIA)	16
ALUMÍNIO P/ POLICARBONATO	17
ALUMÍNIO SALA LIMPA	17
ALUMÍNIO P/ LUMINOSOS	17
DEMONSTRATIVO/PERFIS SACADA	18
PERFIS FECHAM. DE SACADA	18
ACES. FECHAM. DE SACADA	20
KIT VERSATIK / KIT TRUCK / KIT TRANSFER	21
KIT BOX / KIT ENGENHARIA / KIT PIA	21



Fone / Fax
11.2241-6700

KITS ESPECIAIS	22
FERRAGENS SANTA MARINA	23
COMPONENTES P/ FERRAGENS	27
LINHA BLINDEX 3000	28
FERRAGENS POLIMERO	29
FERRAGENS ESPECIAIS	29
ACESSÓRIOS P/ CORRIMÃO	29
ACESSÓRIOS EM GERAL	32
PUXADORES	37
FERRAMENTAS	38
APLICAÇÕES	39

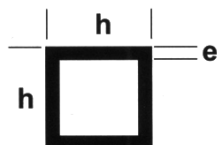

Código Perfil	Kg/m	Tubos Quadrados (mm)		Polegadas
		h	e	h
TUB - 4001	0,2000	12,70	1,50	1/2
TUB - 4002	0,2330	15,90	1,50	5/8
TUB - 4002	0,2840	19,05	1,50	3/4
TUB - 4008	0,3860	25,40	1,50	1
TUB - 4011	0,4910	31,75	1,50	1.1/4
TUB - 4014	0,5910	38,10	1,50	1.1/2
TUB - 4020	1,0550	50,80	2,00	2
TUB - 4023	1,9700	63,50	3,05	2.1/2
TUB - 4024	2,5090	76,20	3,18	3
TUB - 4025	3,9950	101,60	3,80	4

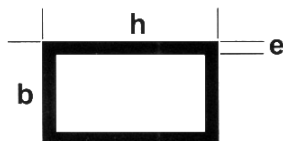

Código Perfil	Kg/m	Tubos Retangulares (mm)			Polegadas	
		B	h	e	b	h
TUB - 4501	0,310	12,70	25,40	1,65	1/2	1
TUB - 4536	0,521	12,70	50,80	1,65	1/2	2
TUB - 4504	0,810	25,40	50,80	2,00	1	2
TUB - 4545	0,645	25,40	38,10	2,00	1	1.1/2
TUB - 4513	0,918	38,10	50,80	2,00	1.1/2	2
TUB - 4543	0,873	38,10	60,30	1,70	1.1/2	2.3/8
TUB - 4517	1,190	38,10	76,20	2,00	1.1/2	3
TUB - 4537	1,750	38,10	101,60	2,40	1.1/2	4
TUB - 4530	2,385	50,80	101,60	3,05	2	4
TUB - 4520	3,193	38,10	152,40	3,18	1.1/2	6
TUB - 4559	3,206	50,80	152,40	3,00	2	6

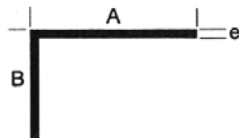

Código Perfil	Kg/m	Cantoneiras de Abas Desiguais (mm)			Polegadas	
		A	B	e	b	h
L - 90	0,150	20,00	10,00	1,20	-	-
L - 93	0,300	25,40	12,70	1,50	1/2	1
L - 100	0,521	38,10	25,40	2,18	1.1/2	1
L - 104	0,600	50,80	25,40	2,18	2	1

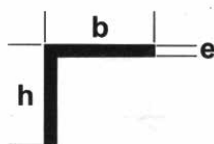

Código Perfil	Kg/m	Cantoneiras de Abas Iguais (mm)			Polegadas	
		h	b	e	b = h	e
L - 002	0,100	12,70	12,70	1,6	1/2	1/16
L - 004	0,150	12,70	12,70	2,38	1/2	3/32
L - 405	0,130	15,88	15,88	1,6	5/8	1/16
L - 009	0,150	19,05	19,05	1,6	3/4	1/16
L - 013	0,210	25,40	25,40	1,6	1	1/16
L - 014	0,410	25,40	25,40	3,2	1	1/8
L - 017	0,330	31,75	31,75	1,6	1.1/4	1/16
L - 018	0,515	31,75	31,75	3,2	1.1/4	1/8
L - 024	0,416	38,10	38,10	1,6	1.1/2	1/16
L - 022	0,620	38,10	38,10	3,2	1.1/2	1/8
L - 023	0,910	38,10	38,10	4,76	1.1/2	3/16
L - 336	0,670	50,80	50,80	2	2	
L - 025	0,840	50,80	50,80	3,2	2	1/8
L - 026	1,240	50,80	50,80	4,76	2	3/16
L - 027	1,620	50,80	50,80	6,35	2	1/4
L - 747	1,298	76,10	76,10	3,2	3	1/8
L - 753	1,758	101,60	101,60	3,2	4	1/8

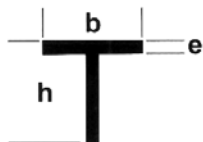

Código Perfil	Kg/m	Perfis T (mm)			Polegadas	
		b	h	e	b	h
T - 003	0,192	19,05	12,70	1,60	3/4	1/2
T - 076	0,213	25,40	25,40	1,60	1	1
T - 012	0,405	25,40	25,40	3,20	1	1
T - 018	0,518	31,75	31,75	3,20	1.1/4	1.1/4
T - 021	0,628	38,10	38,10	3,20	1.1/2	1.1/2
T - 023	0,845	50,80	50,80	3,20	2	2

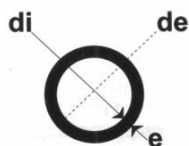

Código Perfil	Kg/m	Tubos Redondos (mm)			Polegadas		
		de	di	e	de	de	e
TUB - 003	0,108	9,53	6,35	1,59	3/8	1/4	1/16
TUB - 010	0,150	12,7	10,22	1,24	1/2	3/8	1/16
TUB - 019	0,192	15,88	12,7	1,59	5/8	1/2	1/16
TUB - 028	0,234	19,05	15,87	1,59	3/4	5/8	1/16
TUB - 038	0,278	22,23	19,05	1,59	7/8	3/4	1/16
TUB - 046	0,320	25,4	22,22	1,59	1	7/8	1/16
TUB - 058	0,405	31,75	28,57	1,59	1.1/4	1.1/8	1/16
TUB - 061	0,770	31,75	25,39	3,18	1.1/4	1	1/8
TUB - 069	0,467	38,1	35,1	1,5	1.1/2	-	-
TUB - 092	1,285	50,8	44,44	1,50	2	1.3/4	1/16
TUB - 167	1,870	76,2	70,2	1,50	3	-	1/16
TUB - 649	2,645	101,60	95,26	1,5	4	3.3/4	1/8

PERFIS P/ VIDRO DE 10mm

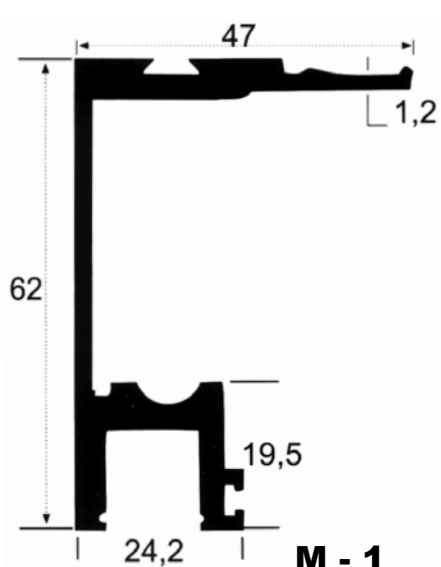

M - 1
1,390 kg/m

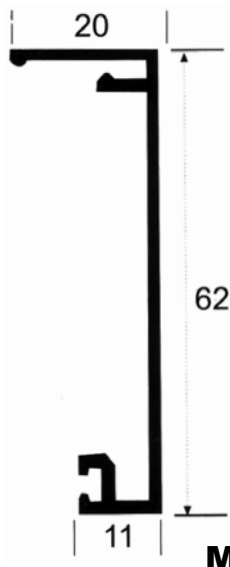

M - 2
0,440 kg/m

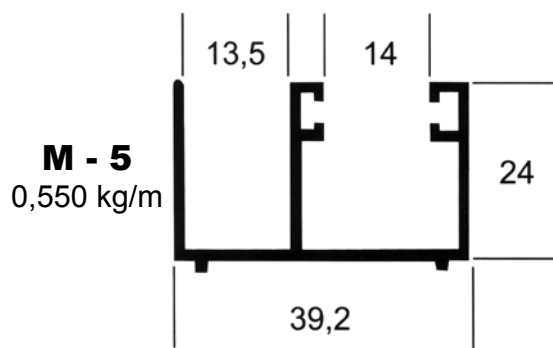

M - 5
0,550 kg/m

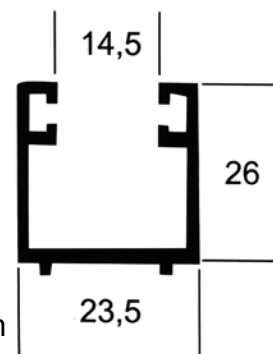

M - 6
0,371 kg/m

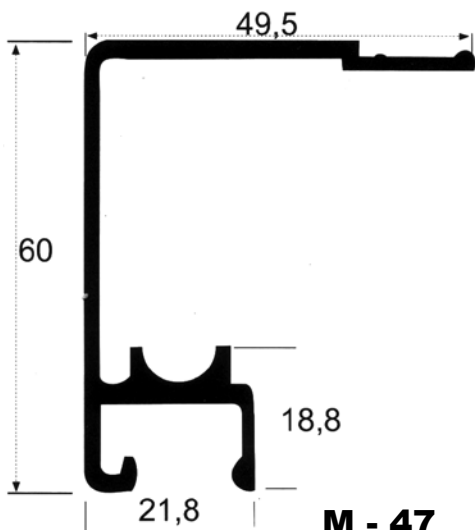

M - 47
0,830 kg/m

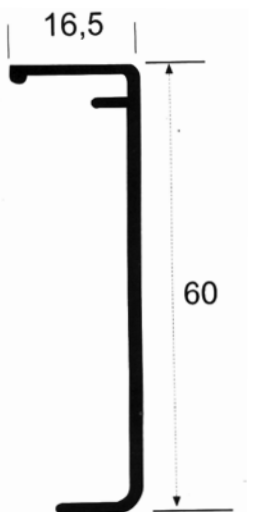

M - 48
0,295 kg/m

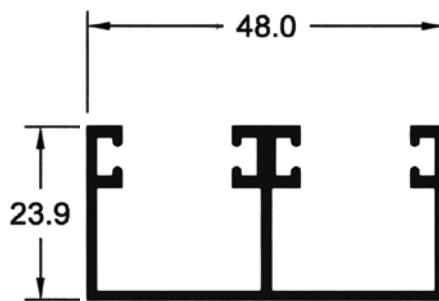

M - 6/B (10mm)
0,633 kg/m

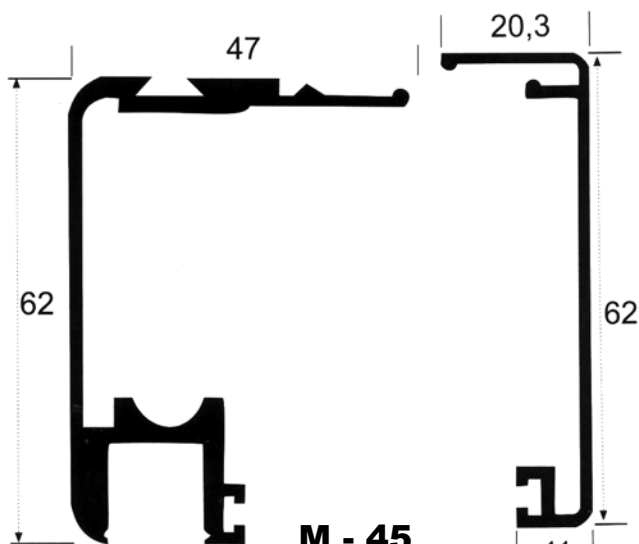

M - 45
0,971 kg/m

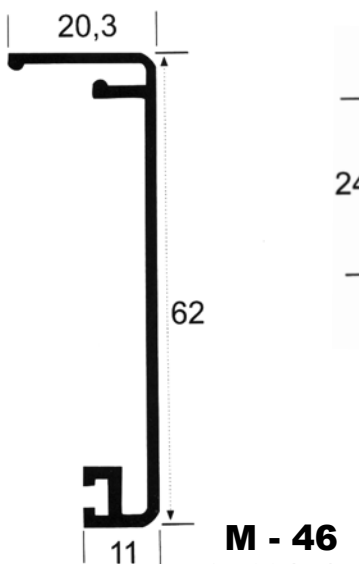

M - 46
0,433 kg/m

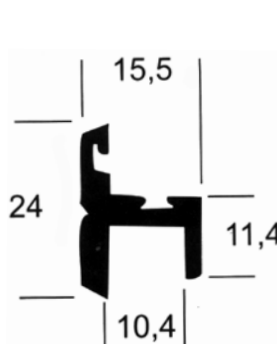

M - 8
0,304 kg/m

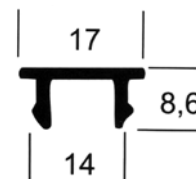

M - 9
0,119 kg/m

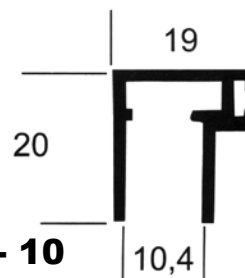

M - 10
0,263 kg/m

PERFIS P/ VIDRO DE 10mm

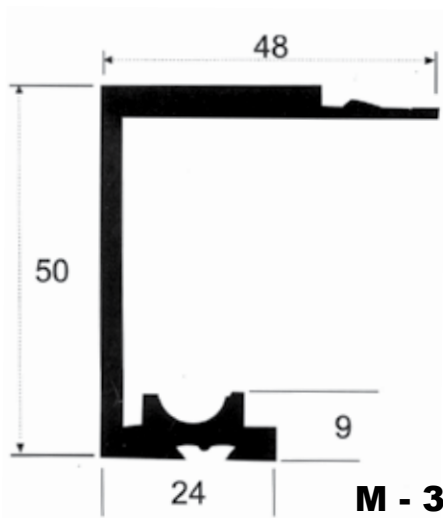

M - 3
1,144 kg/m

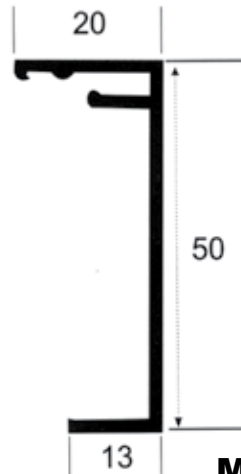

M - 4
0,344 kg/m



M - 12
0,173 kg/m



M - 15
0,255 kg/m

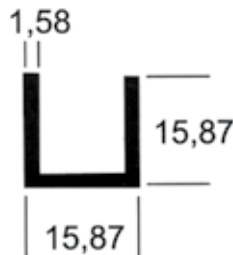

M - 18
0,192 kg/m

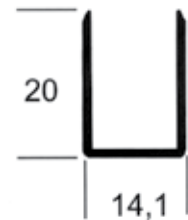

M - 24
0,175 kg/m



M - 15/B
0,433 kg/m

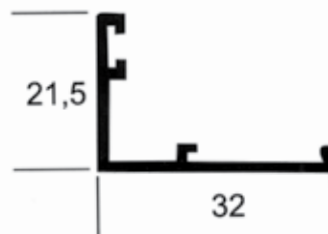

M - 40
0,270 kg/m

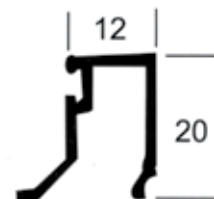

M - 41
0,195 kg/m

PERFIS P/ VIDRO DE 8mm

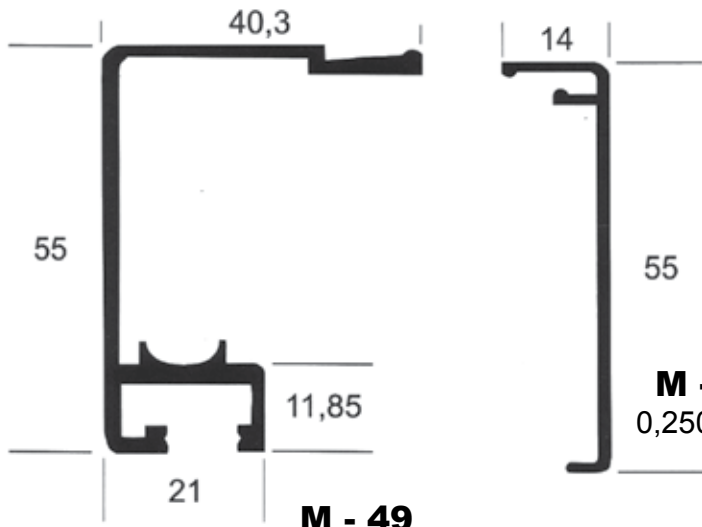

M - 49
0,790 kg/m

M - 50
0,250 kg/m

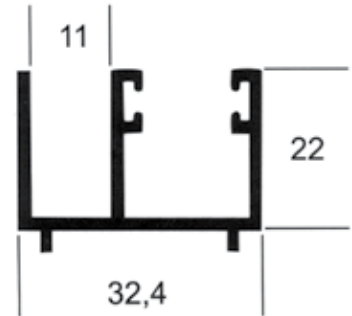

M - 55
0,500 kg/m

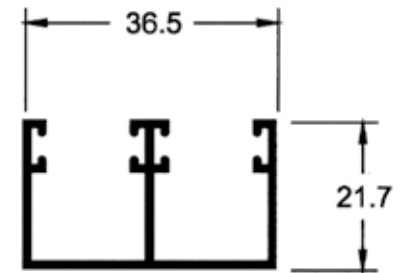

M - 6/B (8mm)
0,533 kg/m

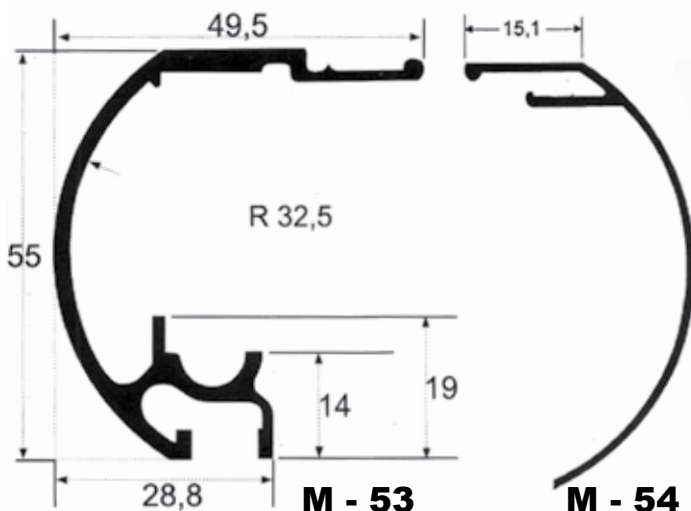

M - 53
0,804 kg/m

M - 54
0,282 kg/m

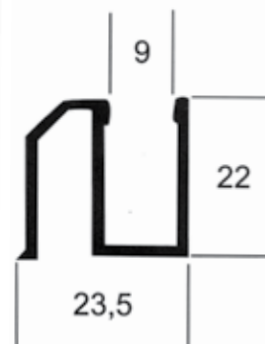

M - 58
0,302 kg/m

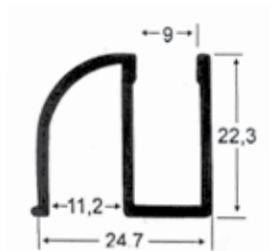

M - 69
0,289 kg/m

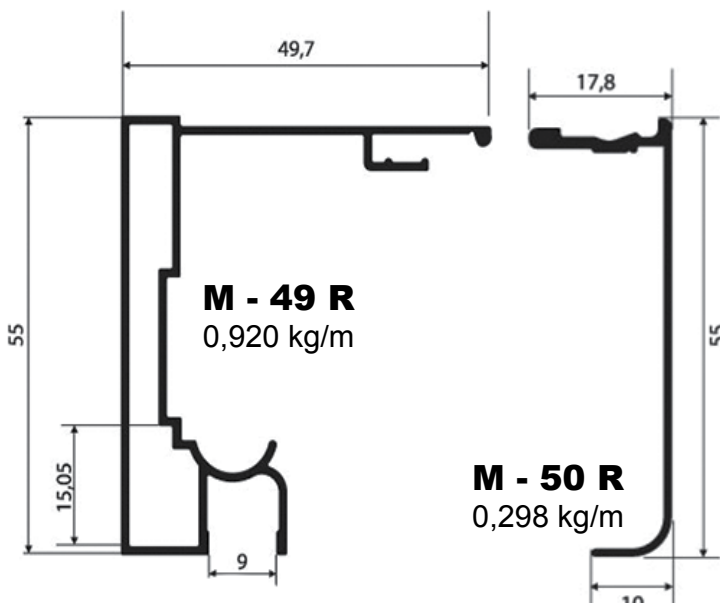

M - 49 R
0,920 kg/m

M - 50 R
0,298 kg/m

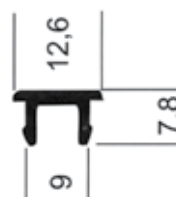

M - 57
0,099 kg/m

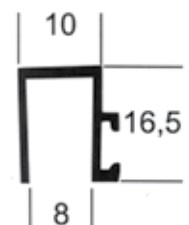

M - 11
0,200 kg/m

PERFIS P/ VIDRO DE 8mm

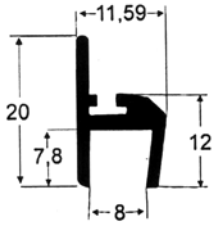

M - 71
0,168 kg/m

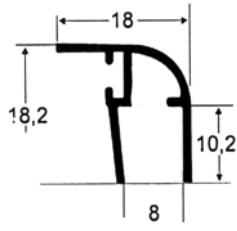

M - 72
0,158 kg/m

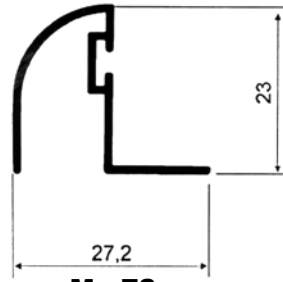

M - 73
0,240 kg/m



M - 13
0,173 kg/m

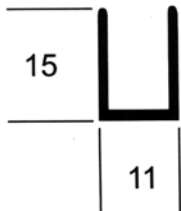

M - 59
0,124 kg/m

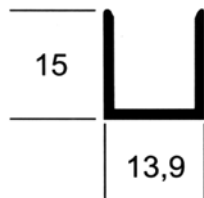

M - 60
0,132 kg/m



M - 61
0,164 kg/m

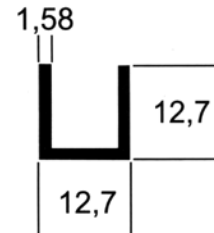

M - 19
0,151 kg/m

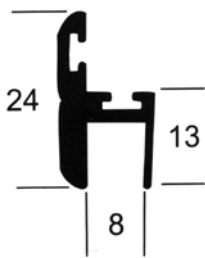

M - 56
0,309 kg/m

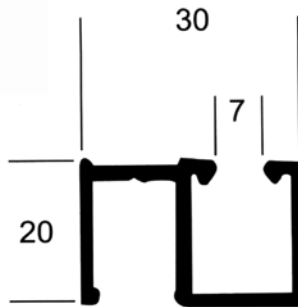

M - 14
0,304 kg/m

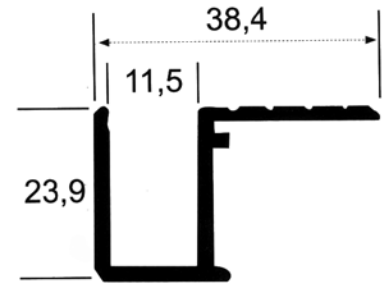

M - 7
0,436 kg/m

DIVERSOS

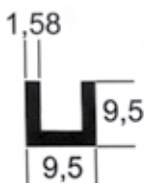

M - 21
0,108 kg/m

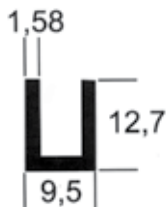

M - 20
0,129 kg/m



M - 17
0,336 kg/m

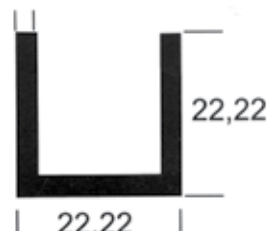

M - 16
0,400 kg/m

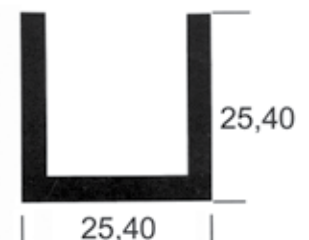

U - 1''
0,490 kg/m

DIVERSOS

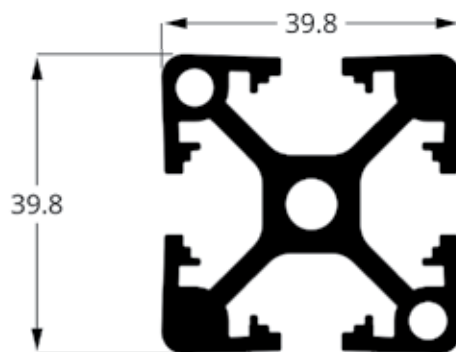
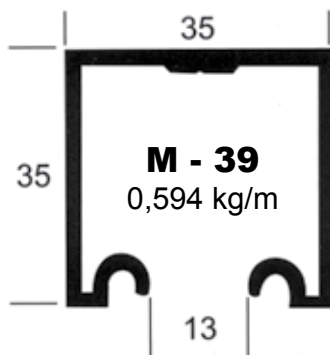
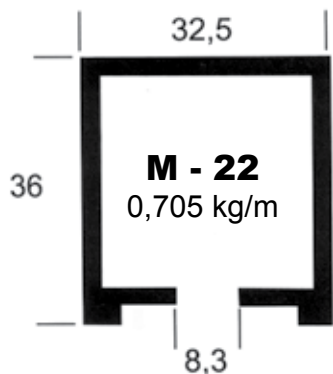
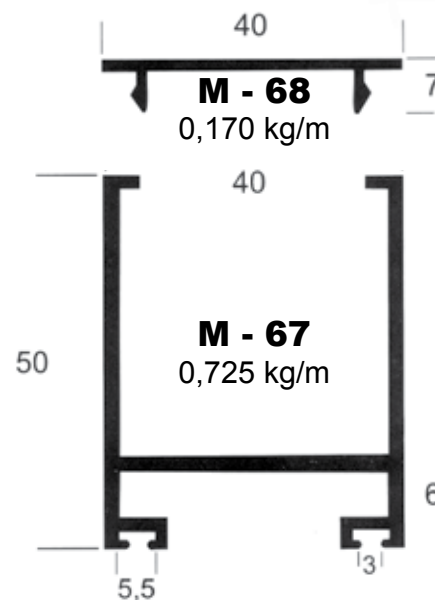
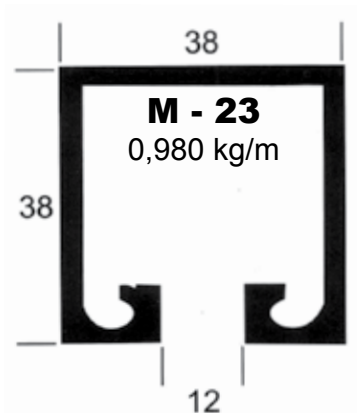
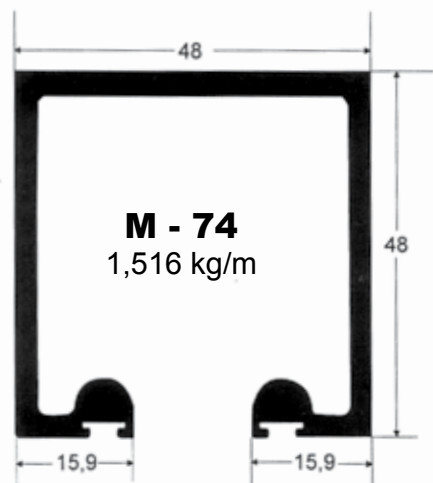

PERFIL ESTRUTURAL

DIVISÓRIA SANITÁRIA

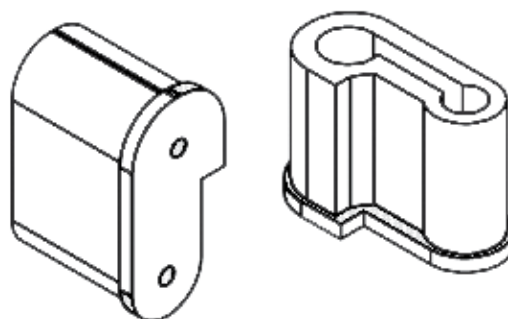
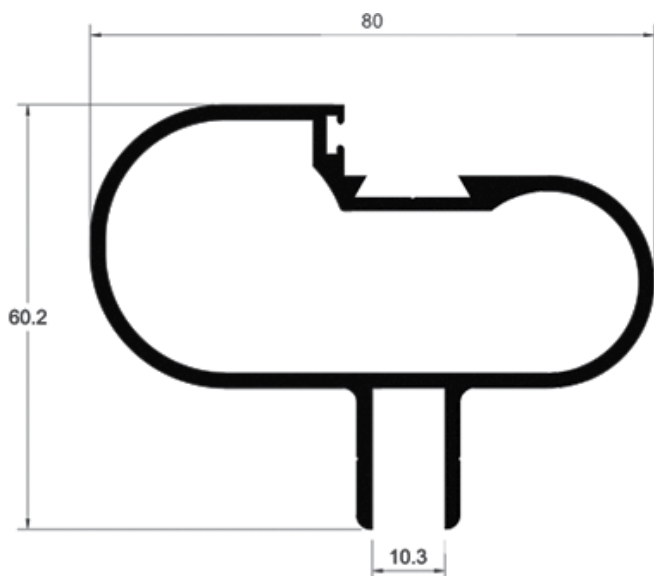

**SAPATA FIXAÇÃO
(DV 300)**

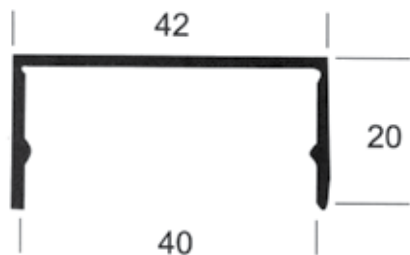

M - 28
0,265 kg/m

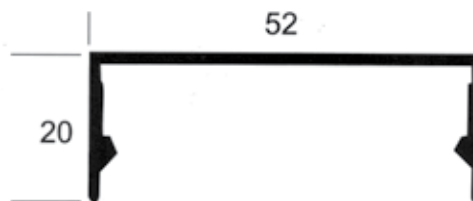

M - 64
0,351 kg/m

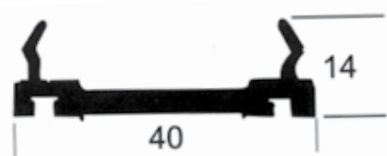

M - 29
0,380 kg/m

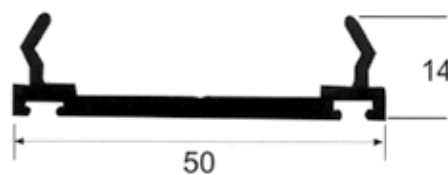

M - 65
0,432 kg/m

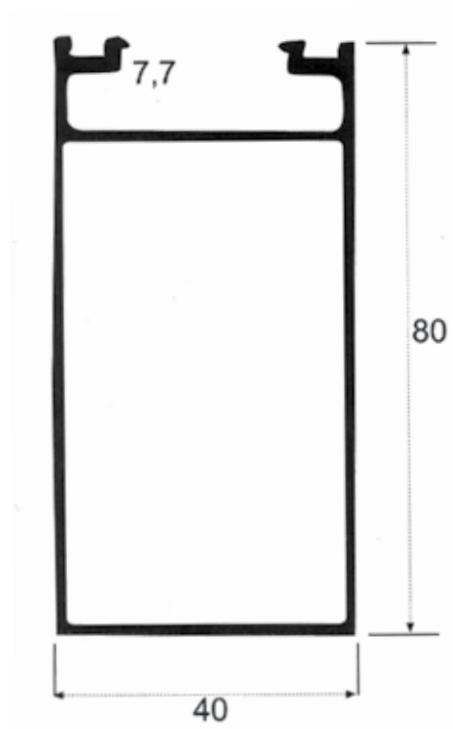

M - 30
1,210 kg/m

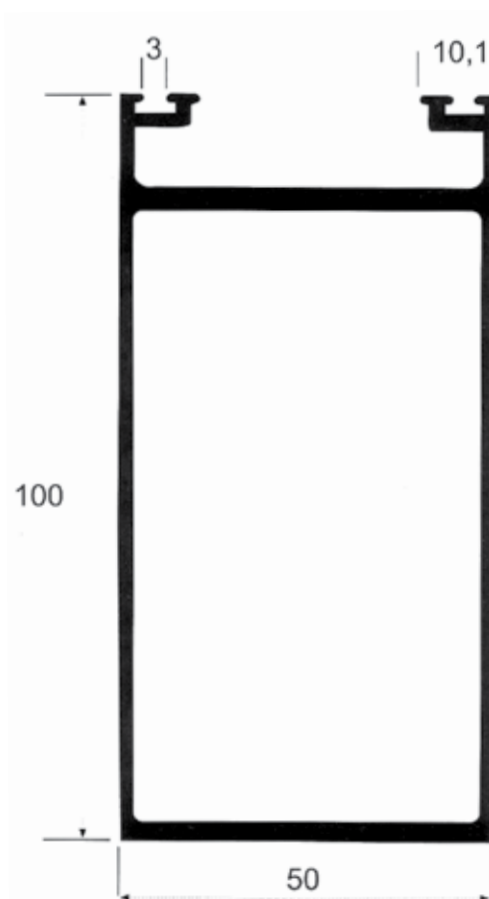

M - 66
1,989 kg/m

GUARDA-CORPO/ CORRIMÃO

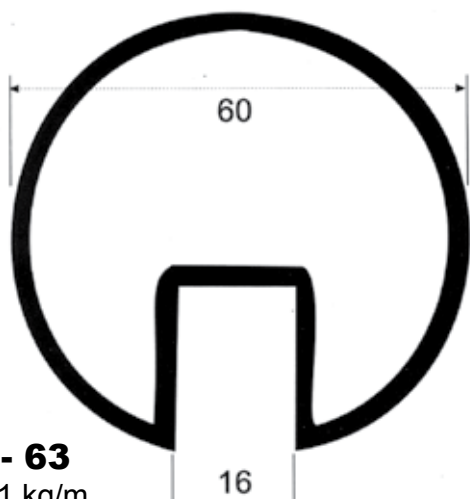

M - 63
1,811 kg/m

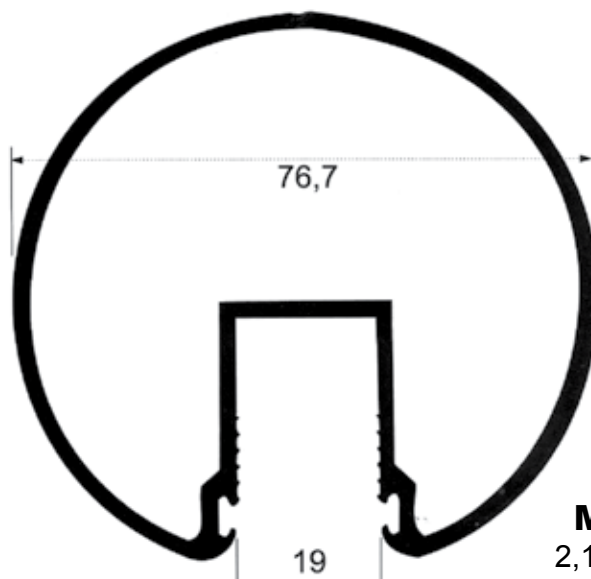

M - 62
2,151 kg/m

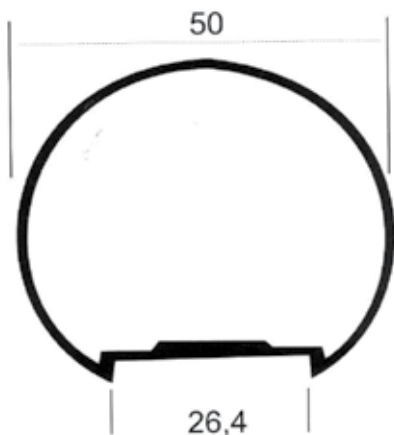

M - 70
0,830 kg/m

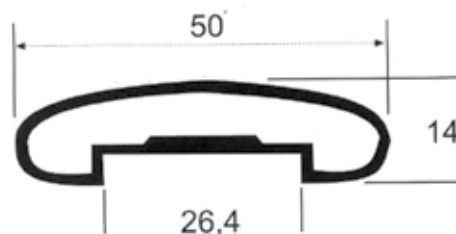

D - 095
0,544 kg/m

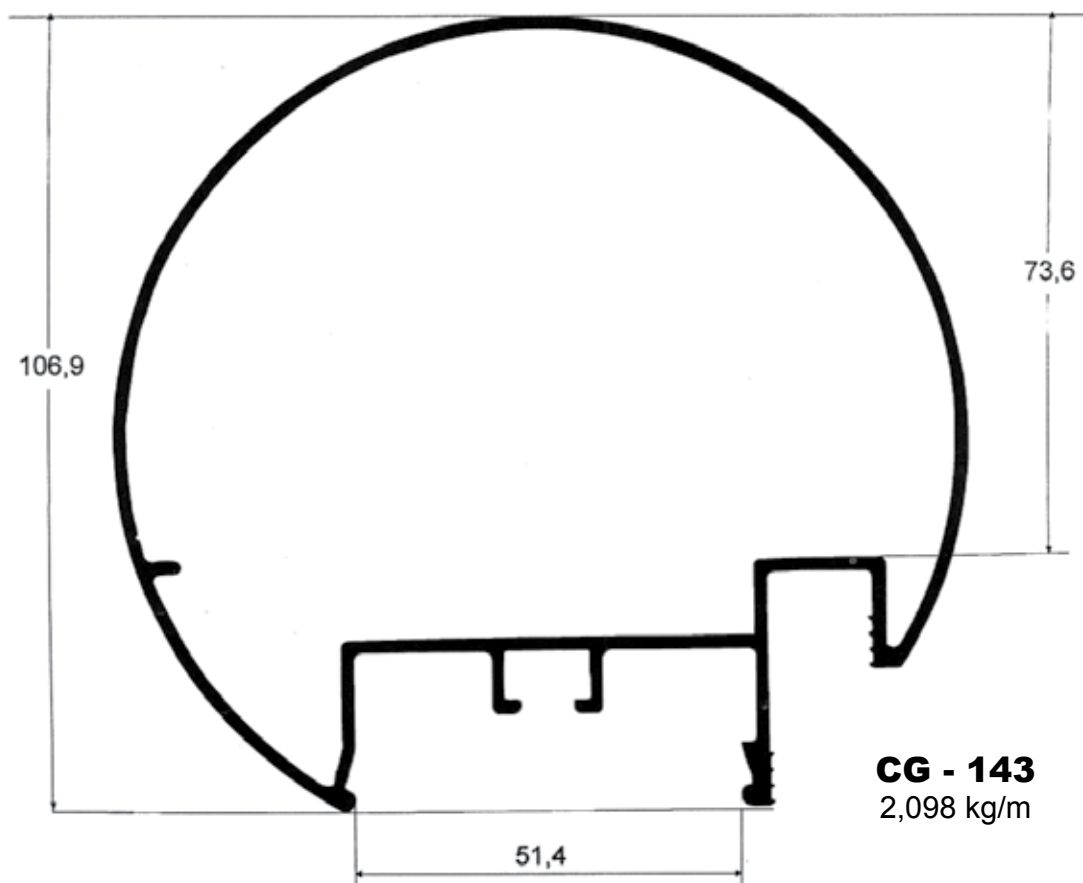

CG - 143
2,098 kg/m

GUARDA-CORPO/ CORRIMÃO

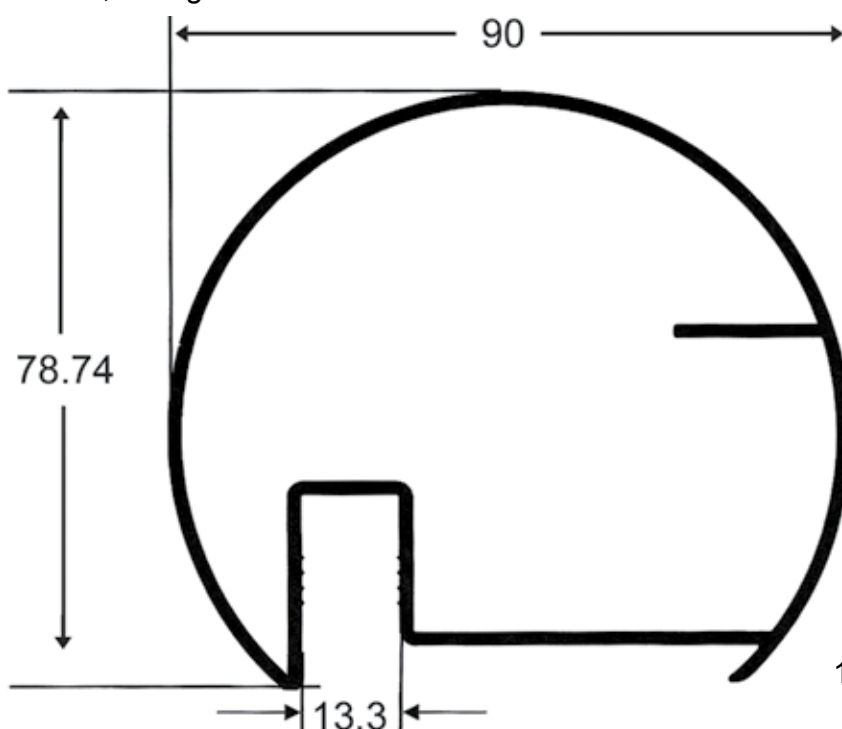
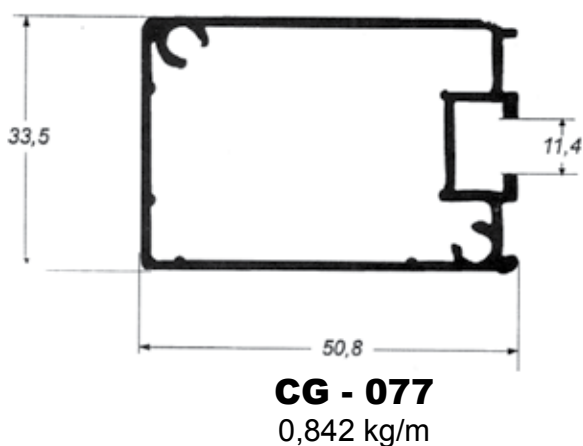
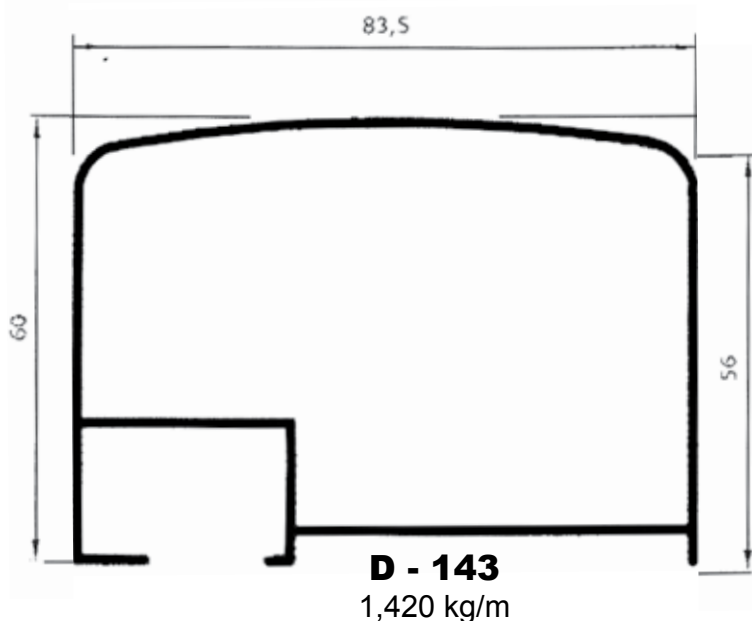
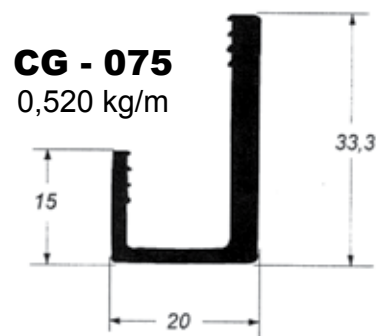
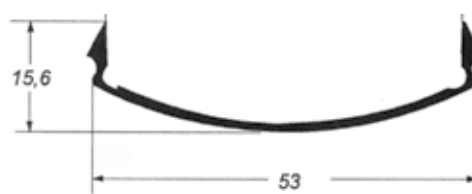
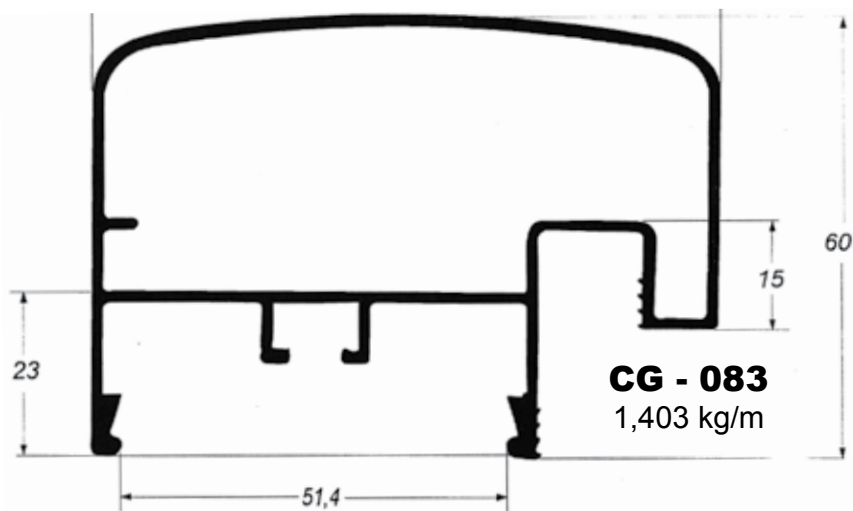

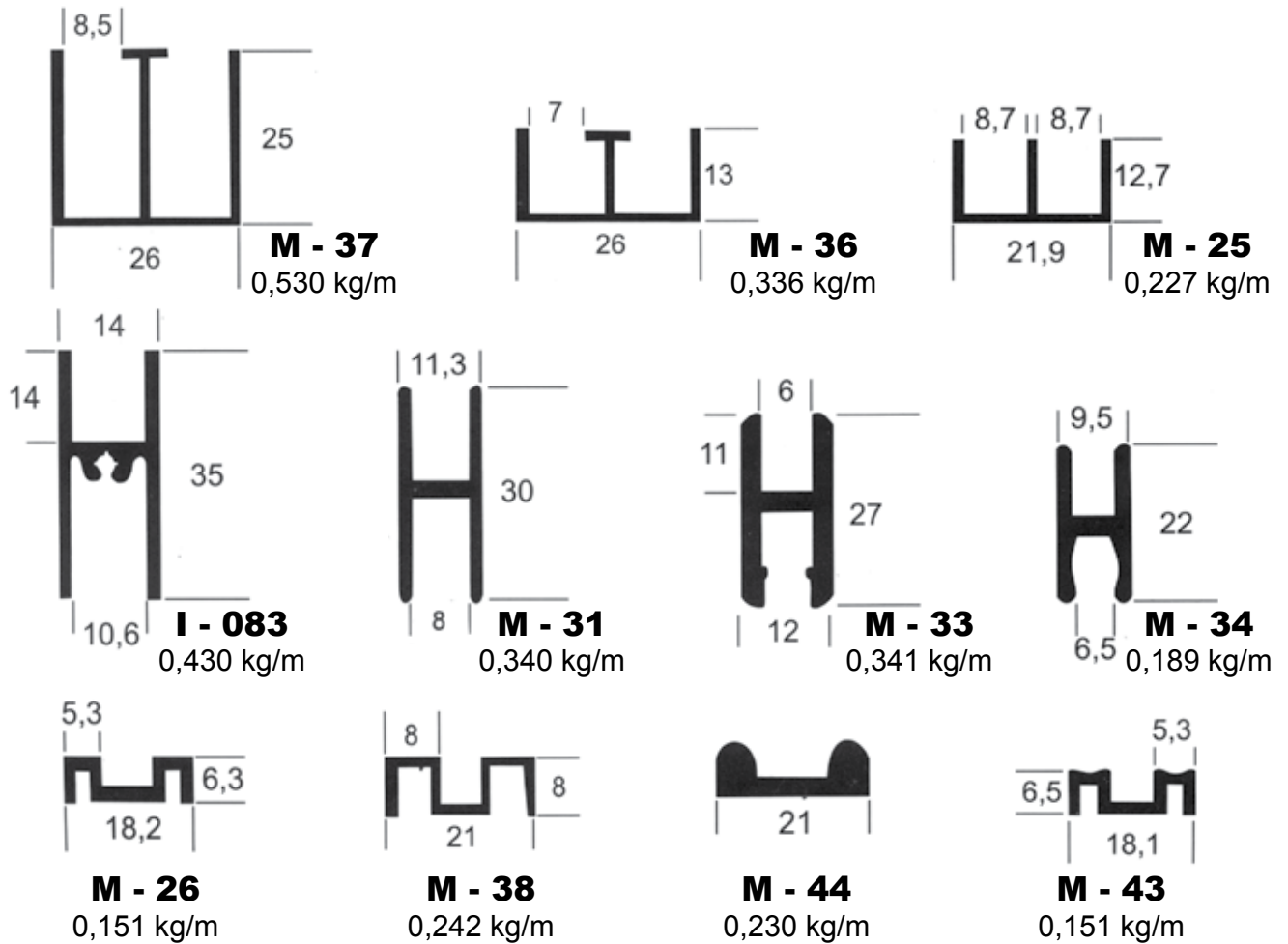

PERFIS TELA MOSQUETEIRA

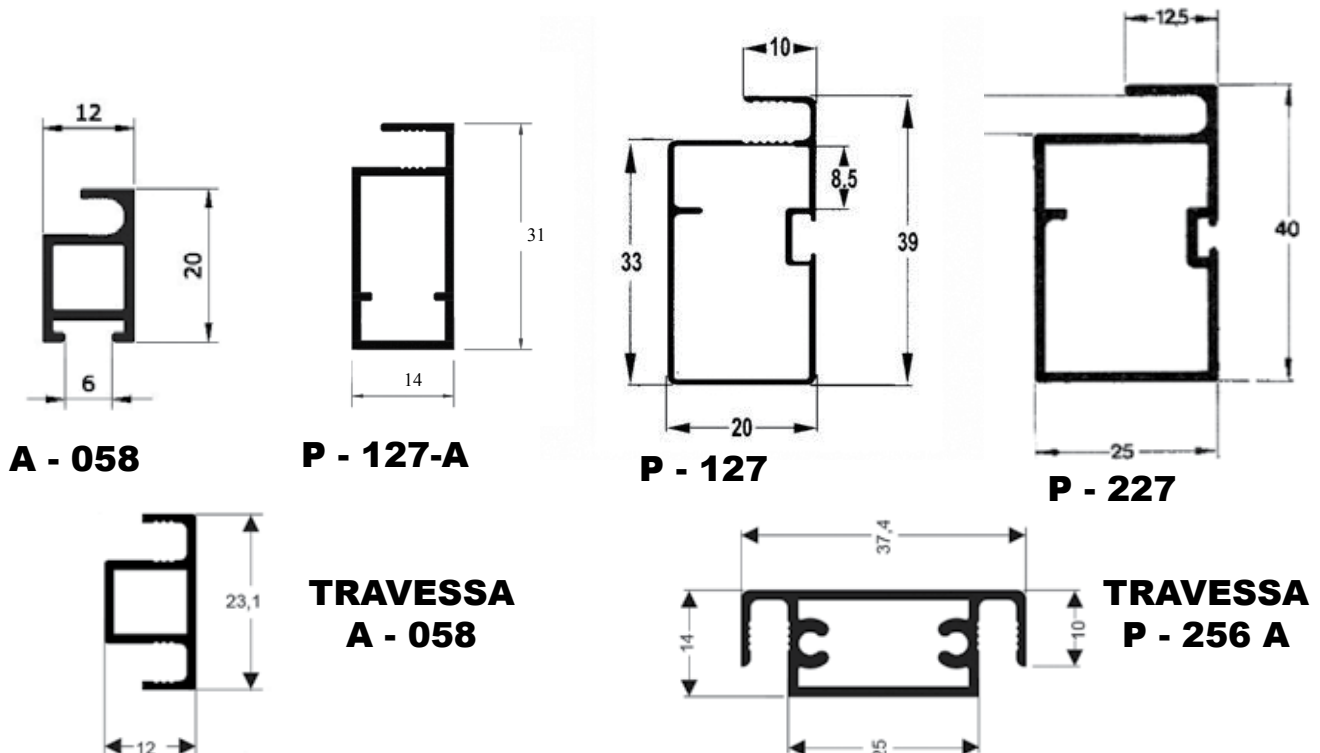

MOLDURAS DE ALUMÍNIO

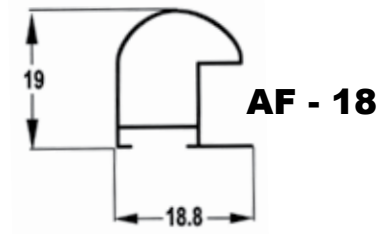
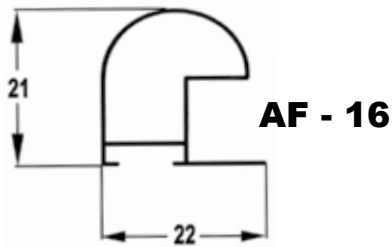
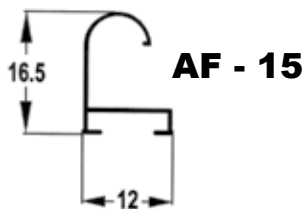
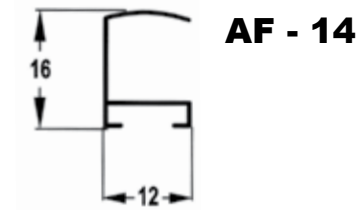
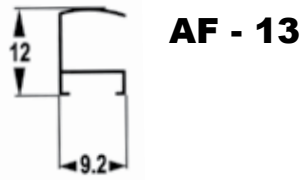
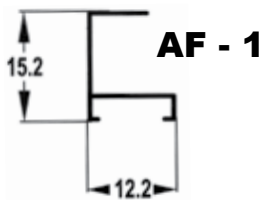

PERFIL P/ MÓVEIS

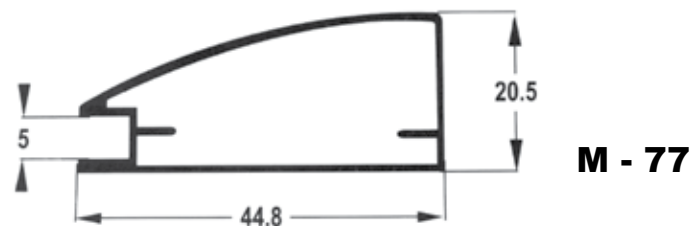

ARREMATES P/ ESCADA E CARROCERIA

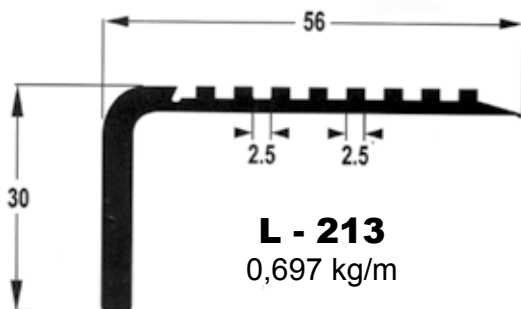

L - 213
0,697 kg/m

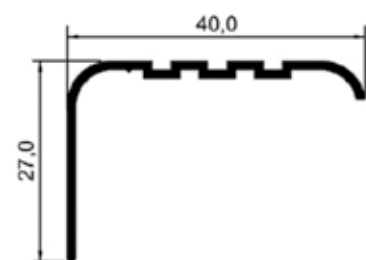

ME - 013
0,323 kg/m

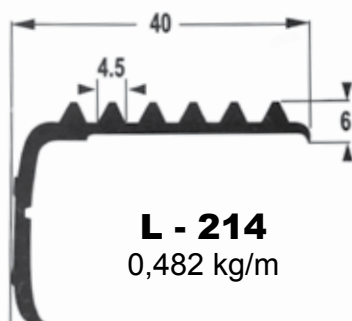

L - 214
0,482 kg/m



L - 460
0,124 kg/m

ALUMÍNIO P/ POLICARBONATO

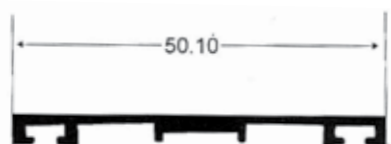

M - 75
0,380 kg/m



M - 76
0,378 kg/m
"TRAPEZIODAL"

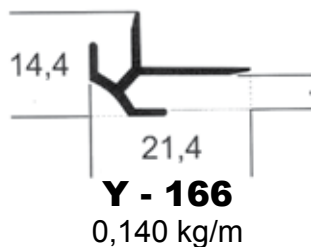

Y - 166
0,140 kg/m

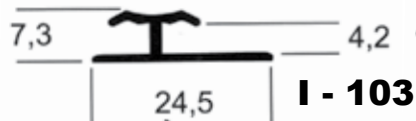

I - 103

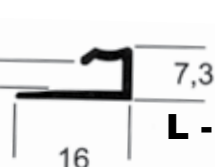

L - 392

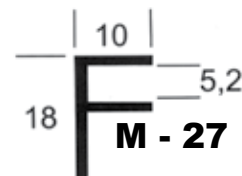

M - 27

ALUMÍNIO SALA LIMPA

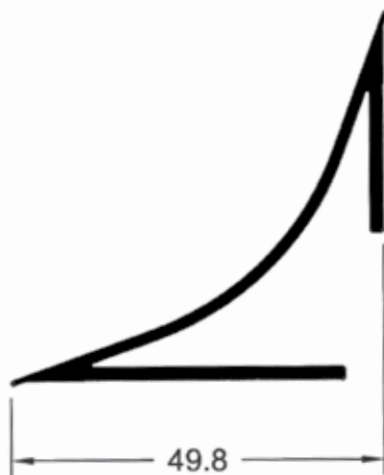

TSL - 003
0,833 kg/m

ALUMÍNIO P/ LUMINOSOS

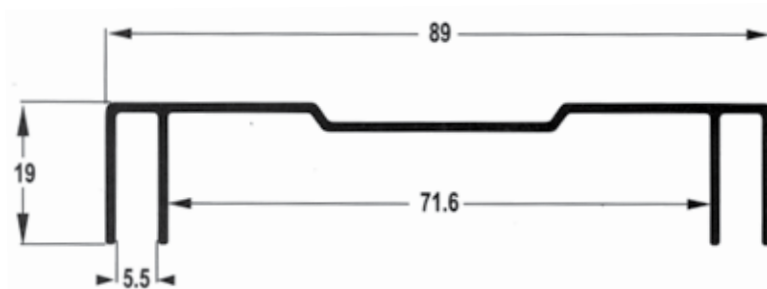

E - 029

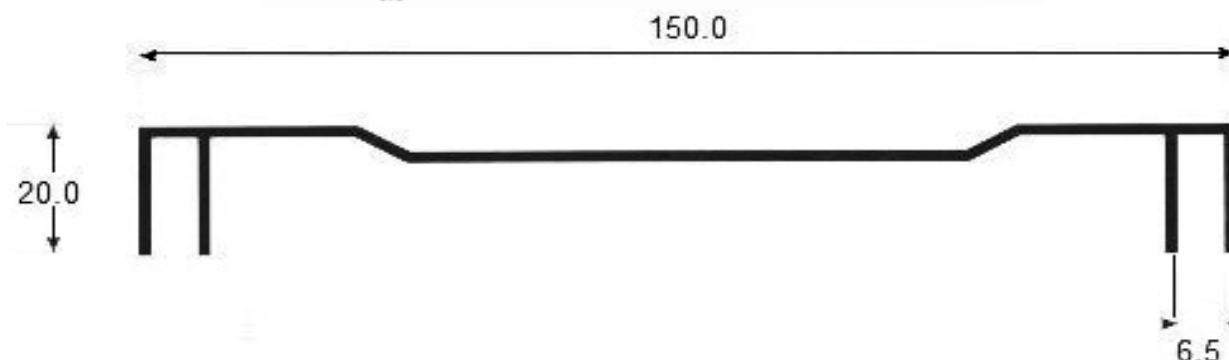

E - 201

DEMONSTRATIVO PERFIS FECHAMENTO DE SACADA



PERFIS P/ FECHAMENTO DE SACADA

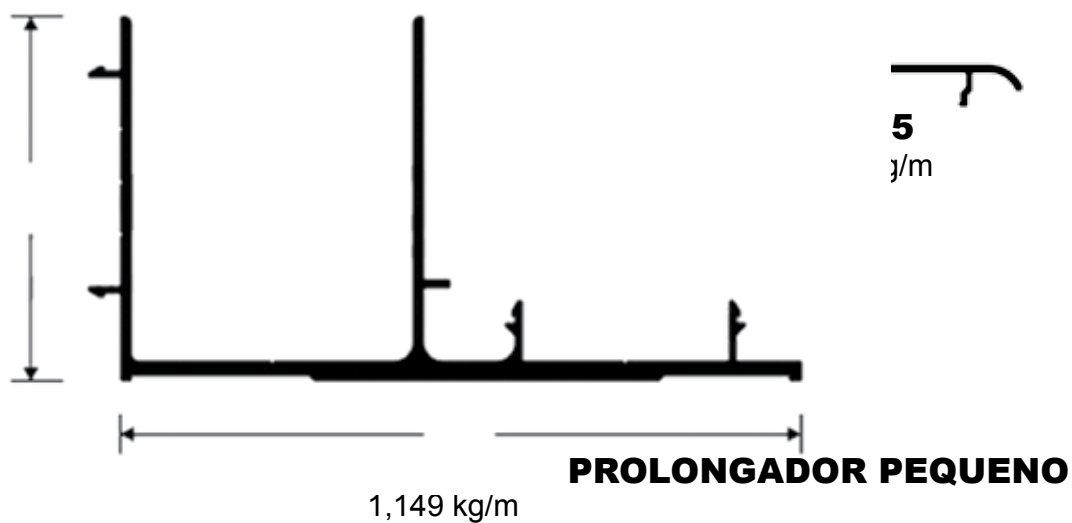

PERFIS P/ FECHAMENTO DE SACADA



M - 80
0,481 kg/m



M - 81
0,488 kg/m



M - 13
0,173 kg/m



M - 85
0,199 kg/m

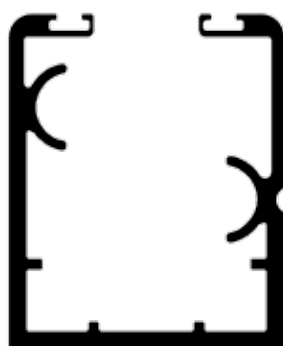

M - 82
1,002 kg/m

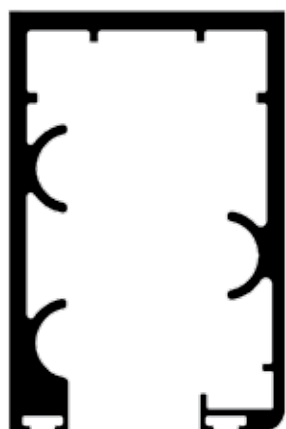

M - 83
1,306 kg/m

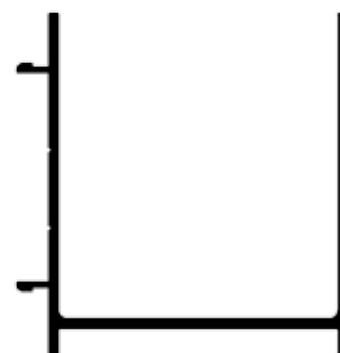

M - 84
0,592 kg/m

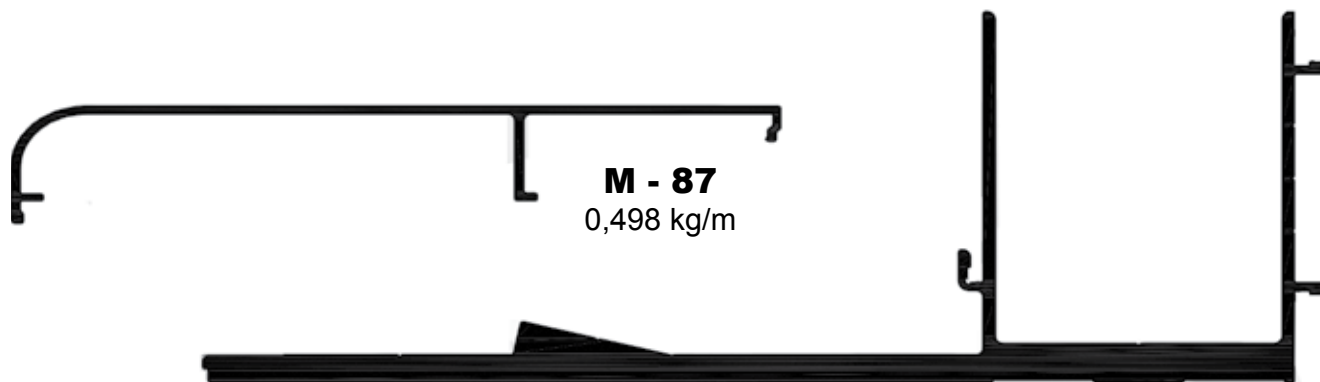
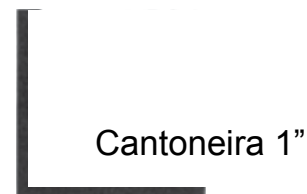

M - 87
0,498 kg/m

M - 86
2,239 kg/m

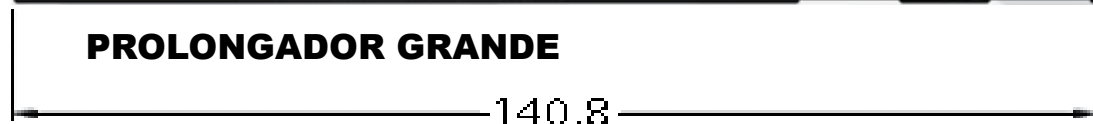

ACESSÓRIOS FECHAMENTO DE SACADA



Arremate do leito



Acabamento inferior e superior



Guia (casinha)



Estacionamento simples



Estacionamento duplo



Estacionamento de alumínio



Mola guia



Guia de saída direita \ esquerda

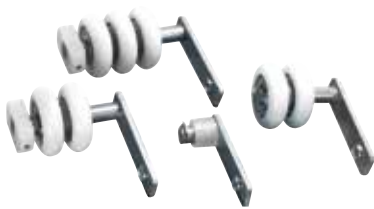

Kit roldana com regulagem e sem regulagem

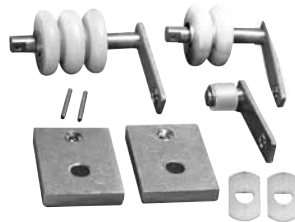

Kit batente



Roldanas duplas e triplas com e sem freio, com e sem regulagem



Pivot (pino guia)



Aparador de inox ou alumínio (15, 25, 35, 45 e 65cm)



Fecho com chave



Fechadura



Borracha de silicone para vedação (incolor)



Escovinhas normais e auto-adesivas



Pesilox incolor, preto e branco

KIT ENGENHARIA "8mm"



KIT VERSATIK
KIT TRUCK
KIT TRANSFER



KIT BOX



KIT PIA

DIVERSAS CORES E MEDIDAS (A PRONTA ENTREGA)



MARTE ALUMÍNIO



Box Elegance
inox

Opção aço inox.



BOX Encanto

Um Encanto de Box



BOX Luna

Elegance nas curvas



vision

Sua nova visão em portas



BOX FLEX

Pequeno sim, apertado jamais



Box Elegance
sua nova opção

1001B



Capota para corrente

1002



Botão de correção

1002L



Botão de correção
(Lâmina)

1002B



Botão de correção
(Lâmina com calota)

1002C



Botão de correção
(Calota)

1003



Corrente para
basculante

1003A



Argolas para corrente

1009



Pivot para peças pivotantes
superiores e inferiores

1013

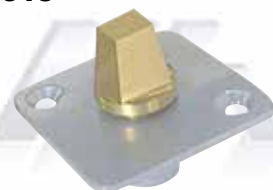

Pivot para
dobradiça inferior

1013S



Pivot inferior para
dobradiça invertida

1014



Pivot para
dobradiça excêntrica

1038



Capuchinho para trinco

1038A



Capuchinho para
trinco e pivot

1038C



Castanha para trinco

1101



Dobradiça superior

1101S



Dobradiça superior invertida

1103

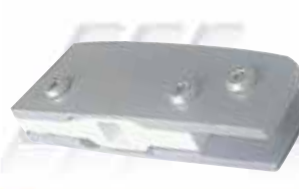

Dobradiça inferior

1103S



Dobradiça inferior invertida

1104



Dobradiça superior
excêntrica direita

1105



Dobradiça superior
excêntrica esquerda

1108



Dobradiça inferior
excêntrica direita

1109



Dobradiça inferior
excêntrica esquerda

1110



Dobradiça pivotante
superior

1112



Dobradiça pivotante
inferior

1114



Dobradiça automática para box

1115



Dobradiça lateral simples

1116



Dobradiça lateral horizontal simples

1117



Dobradiça horizontal dupla

1122



Carrinho duplo com côncavo (M-74)

1122



Carrinho duplo com rebaixo (M-23)

1123



Dobradiça horizontal para basculante

1123A



Dobradiça horizontal para basculante com trinco

1126



Carro duplo para porta de correr com dois rolamentos

1126 CÔNCAVA



Carrinho duplo para porta de correr com rolamento côncavo

1126A



Carrinho para porta de correr com rolamento

1126A CÔNCAVA



Carrinho para porta de correr com rolamento côncavo

1126B



Mini carrinho para porta de correr com rolamento

1126B CÔNCAVA



Mini carrinho para porta de correr com rolamento côncavo

1127



Suporte central com rolamento simples para porta sanfonada

1127A



Suporte central com rolamento inferior

1128A



Dobradiça horizontal lateral com ponto de giro 65mm

1129D



Dobradiça dupla vidro com vidro automática direita

1129E



Dobradiça dupla vidro com vidro automático esquerdo

1130



Suporte com pino para basculante e pivotante

1131



Dobradiça para porta em arco com ponto de giro deslocado a 25mm

1132



Dobradiça horizontal dupla superior e inferior

1136



Dobradiça lateral horizontal

1136B



Dobradiça lateral de batente sem eixo de giro

1137



Dobradiça horizontal dupla

1201



Buchas para pivot e dobradiça

1201S



Pivot para dobradiça

1203



Suporte para bandeira com ponto de giro para dobradiça superior

1209



Facão simples para lateral e bandeira

1230



Suporte para dobradiça basculante

1231



Suporte com ponto de giro para basculante e pivotante

1302



Suporte de canto

1304



Suporte para união de dois vidros sem miolo

1305



Suporte para união de dois vidros intermediários

1306



Suporte com miolo para união de dois vidros

1307



Suporte sem miolo para três vidros em "T"

1308



Suporte com miolo para três vidros em "T"

1309



Suporte sem miolo para união de três vidros em "T"

1310



Suporte para união de três vidros

1315



Suporte para união de três vidros com batadeira

1316



Suporte para união de quatro vidros sem miolo

1319



Suporte para união de quatro vidros em cantoneira

1320



Cantoneira sem miolo

1321

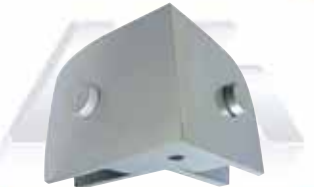

Cantoneira com miolo

1322



Cantoneira para box

1326



Suporte para fixação de vidro fixo no trilho

1329



Suporte de centro

1335



Trinco sem miolo

FERRAGENS SANTA MARINA



1335A



Trinco com miolo

1335C



Contra trinco para 1335

1401



Batedeira simples

1402



Batedeira fixada em bandeira

1502



Trinco inferior

1504



Contra fechadura

1504A



Contra fechadura para alvenaria 1520

1504P



Contra fechadura de pressão para 1520S vista interna

1510



Fechadura bico de papagaio

1510D



Fechadura bico de papagaio para janela direita

1510E



Fechadura bico de papagaio para janela esquerda

1510P



Fechadura de pressão para porte de correr

1511



Contra fechadura para 1510

1511A



Espelho para 1510 alvenaria

1511D



Contra fechadura para 1510D

1511E



Contra fechadura para 1510E

1511P



Contra fechadura de pressão para porte de correr

1519



Trinco inferior

1520



Fechadura central

1520P



Fechadura de pressão

1520 TETRA



Fechadura chave tetra

1523



Trinco com mola para basculante central

1529



Trinco para box

1530



Contra trinco para box

FERRAGENS SANTA MARINA



1530A



Espelho para trinco 1529 para alvenaria

1531



Contra fechadura com aba para 1520

1629



Puxador de box

1629J



Puxador de janela

1636



Prolongador para puxador de vidro

1800



Trinco de pressão

1800A



Trinco de pressão de segurança

1800AT



Trinco de pressão para porta de correr

1800C



Contra trinco de pressão

1801



Chapinha bateadeira para trinco de basculante

1871



Fixador de porta (rodapé)

1872



Fixador de porta (piso)

COMPONENTES FERRAGENS



1404



Guia delrin

1405



Amortecedor

1406



Bateadeira de box



Bucha 1114 e 1115



Pino da 1114



Chave allen para ferragem



Parafuso de ferragem



Pino da 1335

3001



Suporte duplo vertical

3002



Suporte duplo horizontal

3003



Suporte duplo horizontal com capuchinho

3004



Suporte duplo central

3006



Suporte simples vertical

3105



Mancal inferior para porta

3536



Contra fechadura para janela de correr

3107



Mancal superior e lateral retangular

3110



Dobradiça inferior (para mola)

3122



Suporte de batente

3123



Suporte para dobradiça para porta pivotante

3132



Suporte "L" para dobradiça

3140



Dobradiça superior e inferior (para porta sem mola)

3141



Dobradiça para porta pivotante

3143



Dobradiça vidro/vidro

3210



Fechadura de centro

3211



Contra fechadura com aparador (para 3210 e 3214)

3212



Contra fechadura sem aparador (para 3210 e 3214)

3215



Fechadura de piso

3230



Espelho para fechadura com aparador (para 3210 e 3214)

3232



Espelho para fechadura sem aparador

3530



Fechadura para porta de correr

3532



Fechadura para janela de correr sem cilindro externo

3534



Contra fechadura para porta de correr

FERRAGENS POLÍMERO



FERRAGENS ESPECIAIS

1114 ESPECIAL



Dobradiça especial



Mão de amigo (Itaú)



Mão amiga



Puxador (Itaú)

ACESSÓRIOS P/ CORRIMÃO

2002



Tampa da base de 1"

2006



Cachimbo de 1"

2012



Suporte da base de 2"

2013



Tampa da base de 2"

2013T



Tampa de acabamento de 2"

2014



Presilha de 2" com 2 abas

2014-A



Presilha de 2" com 1 aba

2015



Esfera de articulação de 2"

ACESSÓRIOS P/ CORRIMÃO



2016



Tampa da esfera de articulação de 2"

2019



Suporte da base retangular

2020



Tampa da base retangular

2021



Presilha reta com 2 abas

2021-A



Presilha reta com 1 aba

2062-A



Suporte da base quadrada de 2"



Botão de correção



Curva de corrimão



Tampa de corrimão

2061

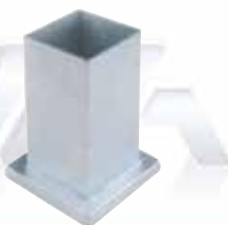

Suporte da base quadrada de 2"



**GUARDA CORPO
INFINITY**



ACESSÓRIOS P/ CORRIMÃO 2"



DISPONIVEL NAS CORES : CROMADO, BRANCO, CINZA FOSCO E PRETO



**TRABALHAMOS TAMBÉM COM TUBO REDONDO 2" EM INOX
*CROMADO E ESCOVADO***

ACESSÓRIOS EM GERAL



Botão de espelho

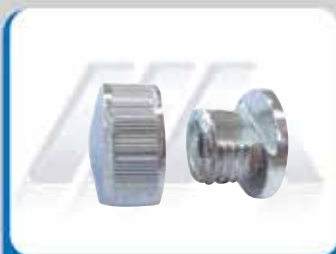

Botão francês (metal e ABS)



L de inox

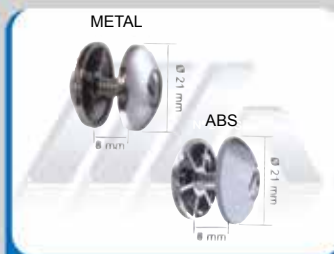

Botão duplo



Suporte fenda C/Acabamento



Suporte fenda Duplo

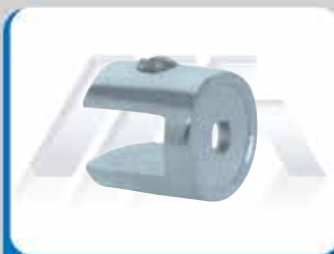

Suporte fenda de 4 a 19mm



Suporte fenda longo de 8 a 10mm



Prolongadores diversos tamanhos

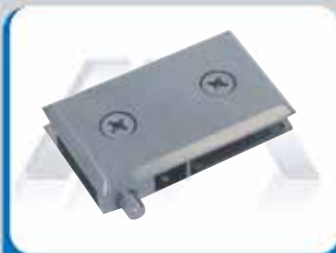

Dobradiça para rack

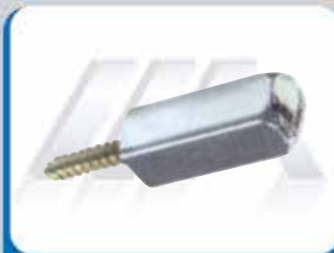

Pitão quadrado pequeno/grande



Pitão redondo pequeno/grande



Dobradiça de rack 1/2 lua



Dobradiça De Rack Vidro Parede



Fechadura para rack



Fechadura plus para rack



Fechadura para vitrine perfil M-33



Fechadura para vitrine jacaré



Fechadura de vitrine perfil M-31



Fixador de piso



Esticador de cabo de aço



Suporte Para Prateleira

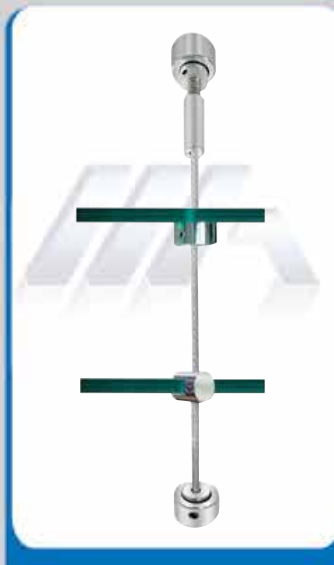

DEMONSTRATIVO

ACESSÓRIOS EM GERAL



Spider de inox
uma ponta



Spider de inox
duas pontas



Spider de inox
três pontas



Spider de inox
quatro pontas



Boton de Inox
s/ regulagem



Boton de Inox
c/ regulagem



Dobradiça Especial
centralizada / descentralizada



Dobradiça Especial (inox)
centralizada / descentralizada



Suporte vidro / haste
toldo de vidro



Suporte alvenaria/haste
toldo de vidro



Haste inox toldo de vidro



Barra de apoio



Torre p/ guarda Corpo

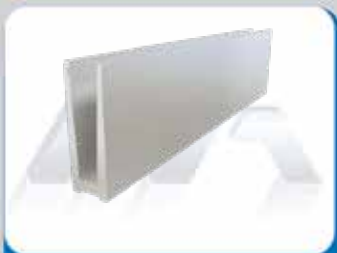

Guarda Corpo (Infinity)



Presilha Redonda
P/Guarda Corpo



Presilha Quadrada
P/Guarda Corpo



Terminal de Ajuste



Terminal Anti-choque

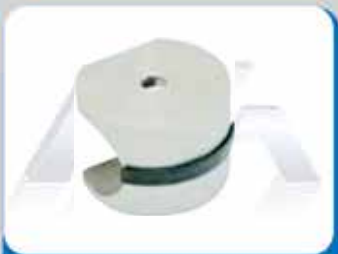

Suporte Barra Alvenaria



Suporte Barra Vidro



Roldana Fechamento de Area



Guia Fechamento de Area



Ventosa de alumínio profissional
simples, dupla e tripla



Tubo de Inox

ACESSÓRIOS EM GERAL



MARTE ALUMÍNIO



DORMA

Mola de piso Dorma



Adaptador para mola
aérea



Mola aérea



Mola de piso importada



Fechadura e contra de pressão
porta de correr



Fechadura elétrica
vidro alvenaria



Fechadura elétrica
vidro vidro



Acionador



Fechadura porta de abrir



Fechadura porte de correr



Suporte para gremalheira
diversos tamanhos



Cremalheira em alumínio



Suporte tucano
moderno



Suporte Pelicano



Suporte tucano 1/2 lua



Suporte tucano
peq., méd. e gde.



Pesilox / Fix tudo



Lâmpada UV



Cola UV



Calha para lâmpada UV



Silicone acético
(todas as cores)



Silicone neutro
(todas as cores)



Fixa espelho



Silicone estrutural

ACESSÓRIOS EM GERAL

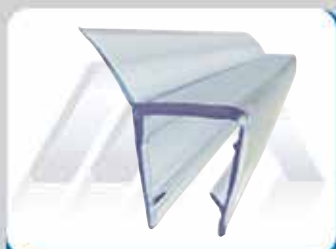

Cadeira 8/10 mm "PVC"



Pontaletes (Chumbadores)



Escova de vedação
todos os tamanhos



Borracha cunha
todos os modelos



Carrinho de vitrine
M-33



Canopla redonda
de alumínio e nylon



Rebites



Espelho convexo
todos os tamanhos



Roldana brock dupla



Roldana brock simples



Roldana para vidro
temperado dupla



Roldana para vidro
temperado excêntrica



Roldana para vidro
temperado simples



Roldana portão latão



Limpador de vidro
desencrost



Protetor de borda
para espelho



Retoque (tira risco de alumínio)



Folha de cortiça



Espuma para vedação
todos os tamanhos



Manta para espelho



Dobradiça Vidro-Alvenaria



Dobradiça Vidro-Vidro



Haste maxmar
vidro/vidro alvenaria



Apoio de silicone
peq. e gde.

ACESSÓRIOS EM GERAL



Puxador concha



Suporte de prateleira
diversos tamanhos

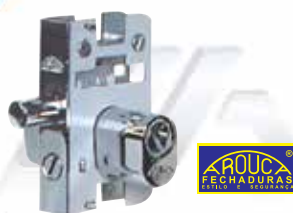

Miolo para fechadura



Vaselina



Manguera de nível



Tampas de nylon para
tubos de alumínio



Tarucel (Diversas medidas)



Tinta alumen



Cola cascola
todos os tamanhos



Desengripante



Compound



Limpador de alumínio



Trinco livre/ocupado



Fechaduras



Fechaduras



Pivot de porta



Primer de silano



Fita dupla face 3M



Fita crepe



Álcool isopropílico



Tela mosquiteiro



Borracha p/ tela



Rolete p/ tela mosquiteiro



Canto 90° (tela)

PUXADORES



Puxador Alça 376



Puxador 376 (1 lado)



Puxador de inox
cód. 433



Puxador de inox
cód. 306



Puxador de inox
cód. 433 grande



Puxador de inox
cód. 887 Gigante



Puxador de inox
cód. 208



Puxador de inox
cód. 209



Puxador de inox
cód. 436-S



Puxador de inox
cód. 438 quadrado



Puxador de inox
cód. 655



Puxador barra Chata
Diversas medidas



Puxador de vidro



Puxador de madeira



Puxador de resina
peq. e gde.



Puxador Inox 304
Cromado/Escovado



Esquadro



Espátula para vidraceiro



Alicate bico de pato para vidraceiro



Estiletes



Alicates



Lixa para vidraceiro



Luva emborrachada para vidraceiro



Caixa de ferramentas



Nível



Martelo pena todas as medidas



Metro profissional



Compasso para corte de vidro



Parafusos



Brocas



Buchas



Pião escarilhador



Rebitador profissional



Aplicador de silicone e PU profissional



Arco de serra profissional



Serra Starret



Trenas



Diamante profissional Toyo



Broca diamantada para mármore, granitos e vidro de 4mm a 100mm



Chave fenda / philips

APLICAÇÕES

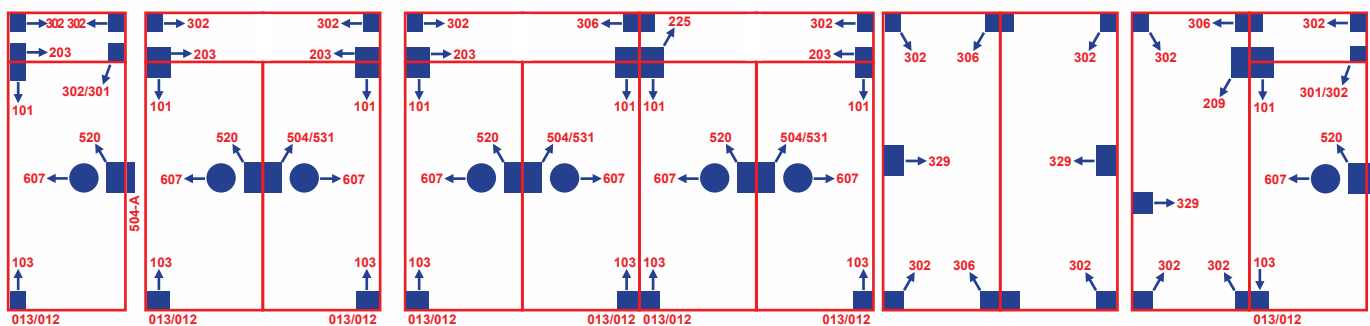
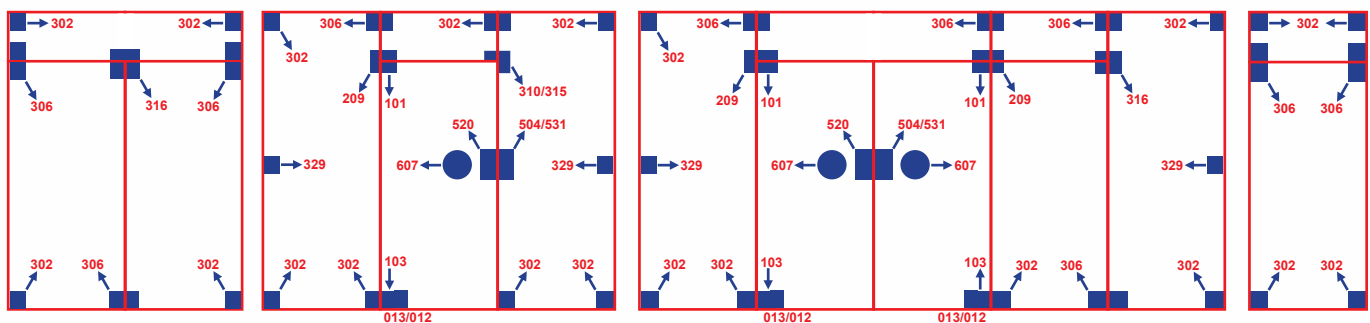
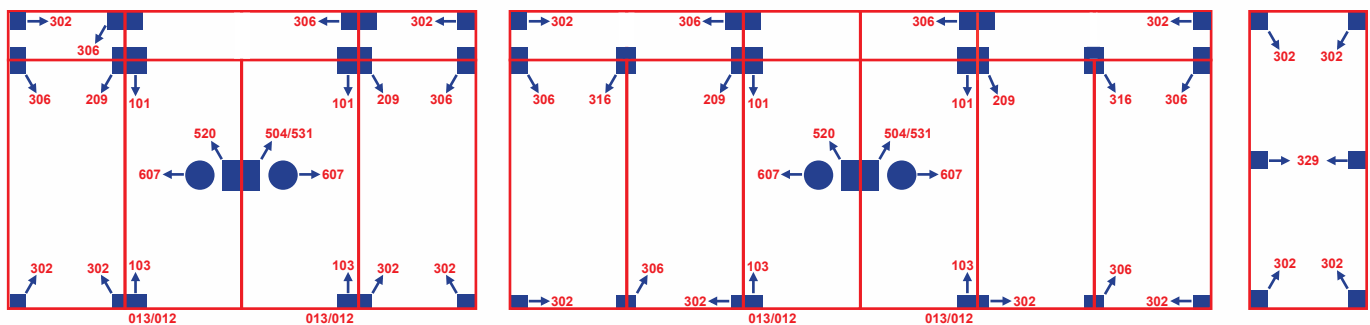
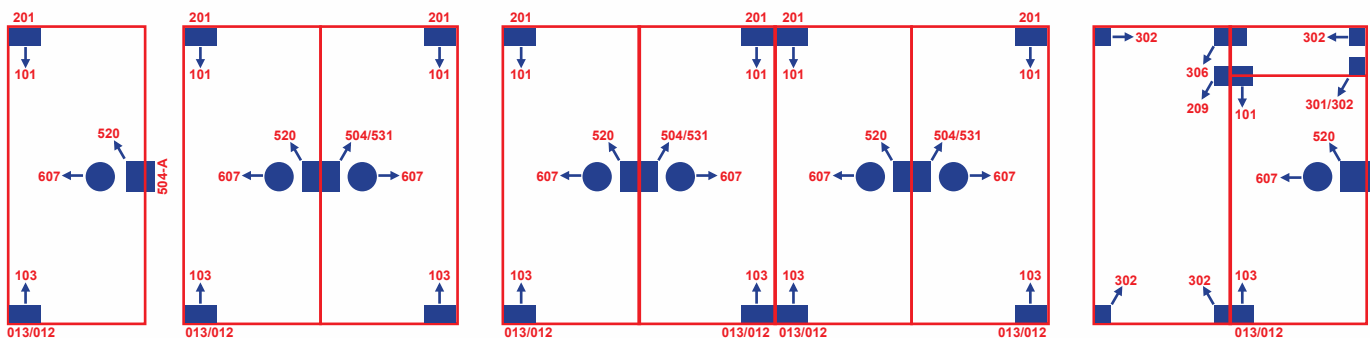
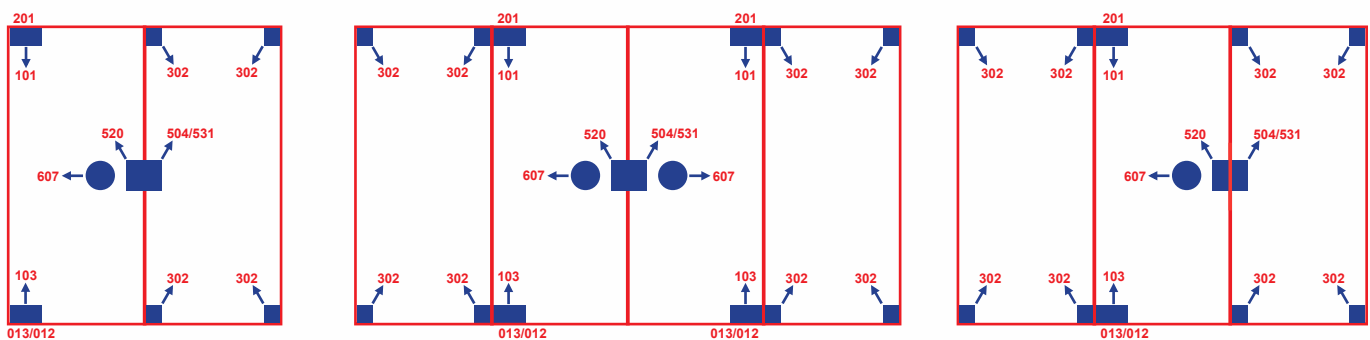

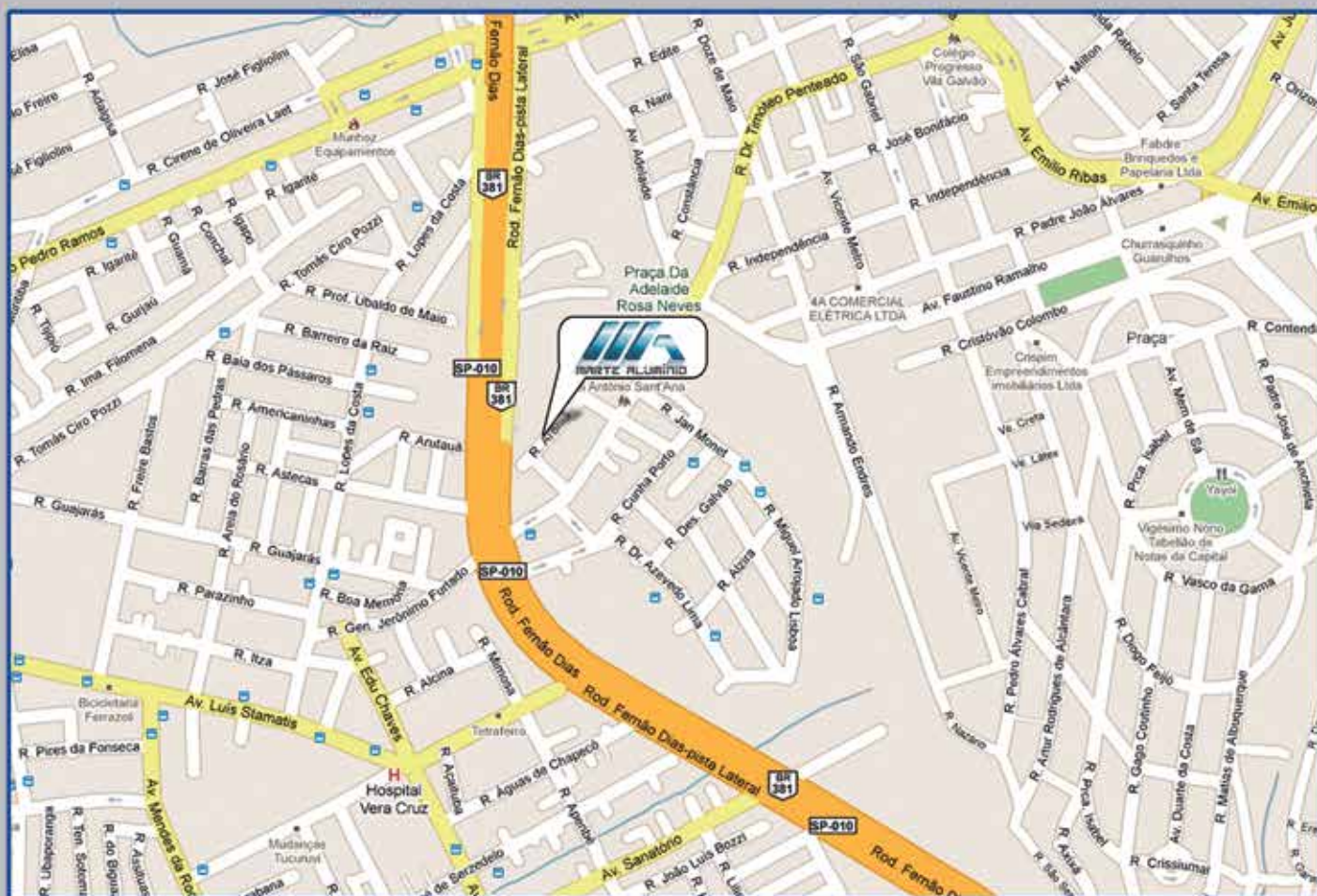

Rua Arumã, 84 - Jardim Modelo
Cep: 02237-030 - São Paulo - SP
www.martealuminio.com.br
martealuminio@martealuminio.com.br